



Your Smart Tube Bender

www.ylm.com.tw



YING HAN Technology Co., Ltd.

CNC
ELECTRIC
TUBE
BENDER



Your Smart Tube Bender

CNC
ELECTRIC
TUBE
BENDER



2018.Jun.

Stock Code:4562





The Development of

YING HAN TECHNOLOGY CO., LTD.

1976 → 1990

From 1976 to 1990, although in small scale, YLM was endeavoring in the development of cold bending technology for metallic pipes, with its applications exporting to Manufacturers of furniture/sport equipment in Asia. YLM's tube bender had been reputed in light industry for its "Practical, Durable & Useful".

1990 → 2005

1990 to 2005, with the essence 'Your leading Machine', YLM had migrated into global automotive industry, and initiated the innovation of cold bending industry in delicacy parts of Automobile/Motorcycle, which has made YLM a well-known manufacturer, ranking in the top 5 intelligent tube bending machines brands, with market share over main competitors in European and US.

2006 → 2016

2006 to 2016, the most important period for well-developed of YLM, for its high market share worldwide as well as commitment of service. By setting up service and maintenance centers in all main industry cities, YLM has shown his determination and promises in customer service, fulfilling the slogan "Global brand, local service" in scale of no time or language difference. Every service center follows '24-hr non-stop' principle, and implements via e-net with Taiwan head quarter, hoping to grow and develop together with our customers. Now YLM has become one of the top 3 tube bender brands worldwide.

Started from manufacturing of precision machine and tools, migration into Industry 4.0 by innovative technology, and achievement of global service net, YLM now is the indispensable manufacturer and partner of global big automotive players, with its complete line of solution, especially for the high-end exhaust system of automobile/truck industry.

YLM has marched into Industry 4.0. Determine to satisfy and grow with our customers is the new spirit of YLM brand.

Drive your productivity gains, and reach Industry 4.0



ALL ELECTRIC CNC Tube Bending Machine

YLM Has Marched Into Industry 4.0

**We Will Do Our Best To Satisfy Our Customers,
And Evolve Our Technology To Match With Our Users' Demands.**

We began our work by producing compact machineries and molds, but now we are stepping into the trend of Industry 4.0, as well as international service system. YLM is an indispensable partner to automotive parts suppliers, in the tube bending sector, especially in the area of high end car exhaust pipe. We are able to provide an integrated production line to our customers, helping them achieve mass production.



ALL ELECTRIC
i Bender

CNC Tube Bending Machine

YLM CNC electric benders energy saving and quiet operation of electric servo control, equipped advanced features and software, to provide the package customers are looking for.



ADVANTAGES

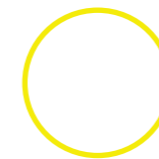

**GREEN PRODUCTION
IN LOW NOISE**

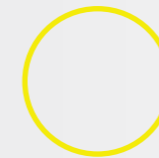

**HIGH MACHINE OUT-PUT With
FAST BENDING SPEED**

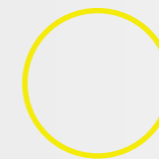

**ENERGY SAVING
ENVIRONMENT FRIENDLY**

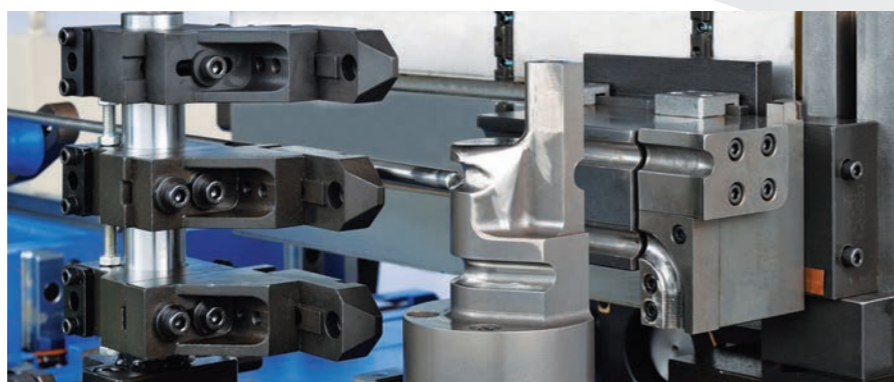
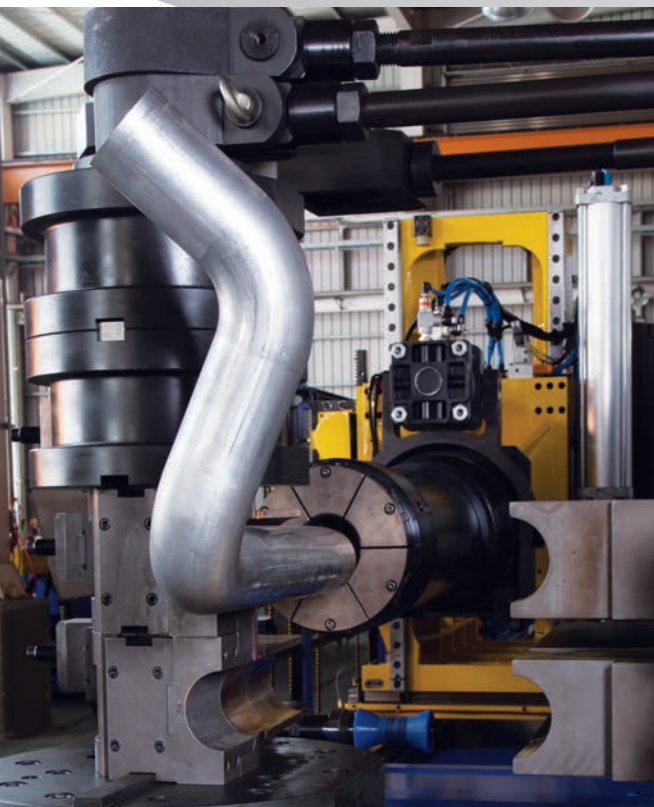

CAN EDIT WORK PROCEDURE RANDOMLY
TEACH-MODE
CNC SOFTWARE

| Line | Feed | Bend | Rotate | Slide | Pressure Die | Clamping Die | Slide U/D | Mandrel |
|------|----------|------|---------|-------|--------------|--------------|-----------|---------|
| 1 | 600.000 | 100 | 180.00 | 100 | 20.00 | 100 | 1 | R 1 SW |
| 2 | 500.000 | 100 | -180.00 | 100 | 20.00 | 100 | 1 | R 1 SW |
| 3 | 700.000 | 100 | 360.00 | 100 | 20.00 | 100 | 1 | R 1 SW |
| 4 | 1000.000 | 100 | 0.00 | 100 | 0.00 | 100 | 1 | R 1 SW |

| Line | X | Y | Z | M |
|------|-------|----------|----------|---|
| 1 | 0.000 | 0.000 | 0.000 | 1 |
| 2 | 0.000 | -189.700 | 0.000 | 1 |
| 3 | 0.000 | -189.700 | -176.200 | 1 |
| 4 | 0.000 | 379.730 | -176.200 | 1 |

Enter Teach Mode

3D SIMULATION

YLM develops our own CNC software which is based on Windows XP / Windows 7 with the ability to import XYZ information from .dxf / STEP files translating to YBC data. YLM software uses 3D simulation software to preview and eliminate bending interferences. YLM software is flexible to meet our clients' requests to achieve efficient production.

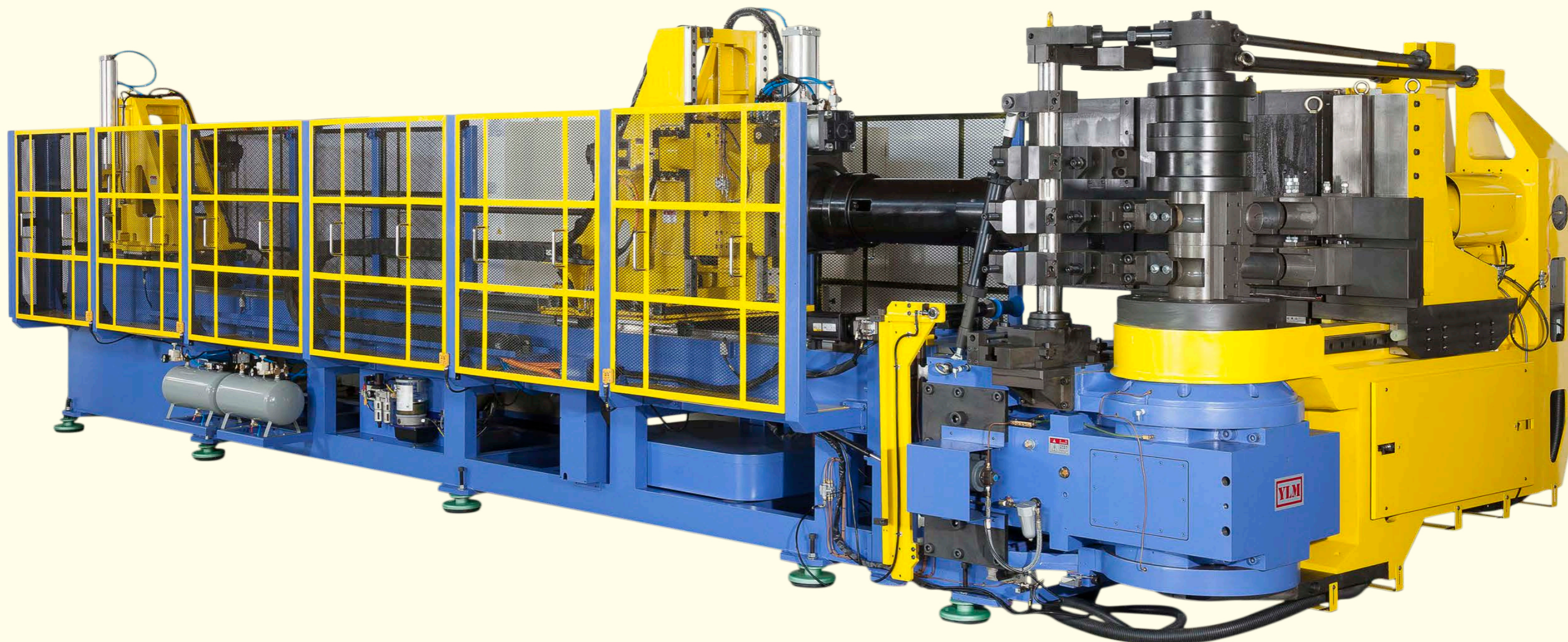

Used for Large Tubes

CNC181 MS-AE-11A

Especially for the production of "thick wall" pipes such as Boiler, Heavy Transportation, Shipbuilding, Chemical Engineering, Power Plant, Diesel Engine

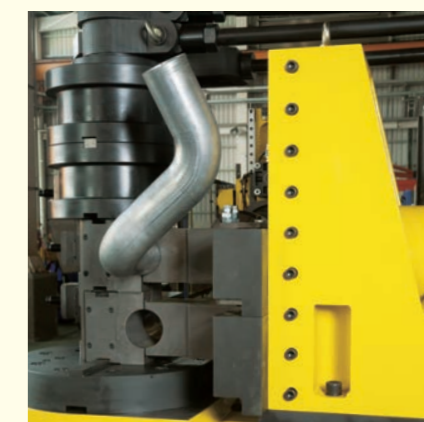

ALL ELECTRIC Smart Tube Bender

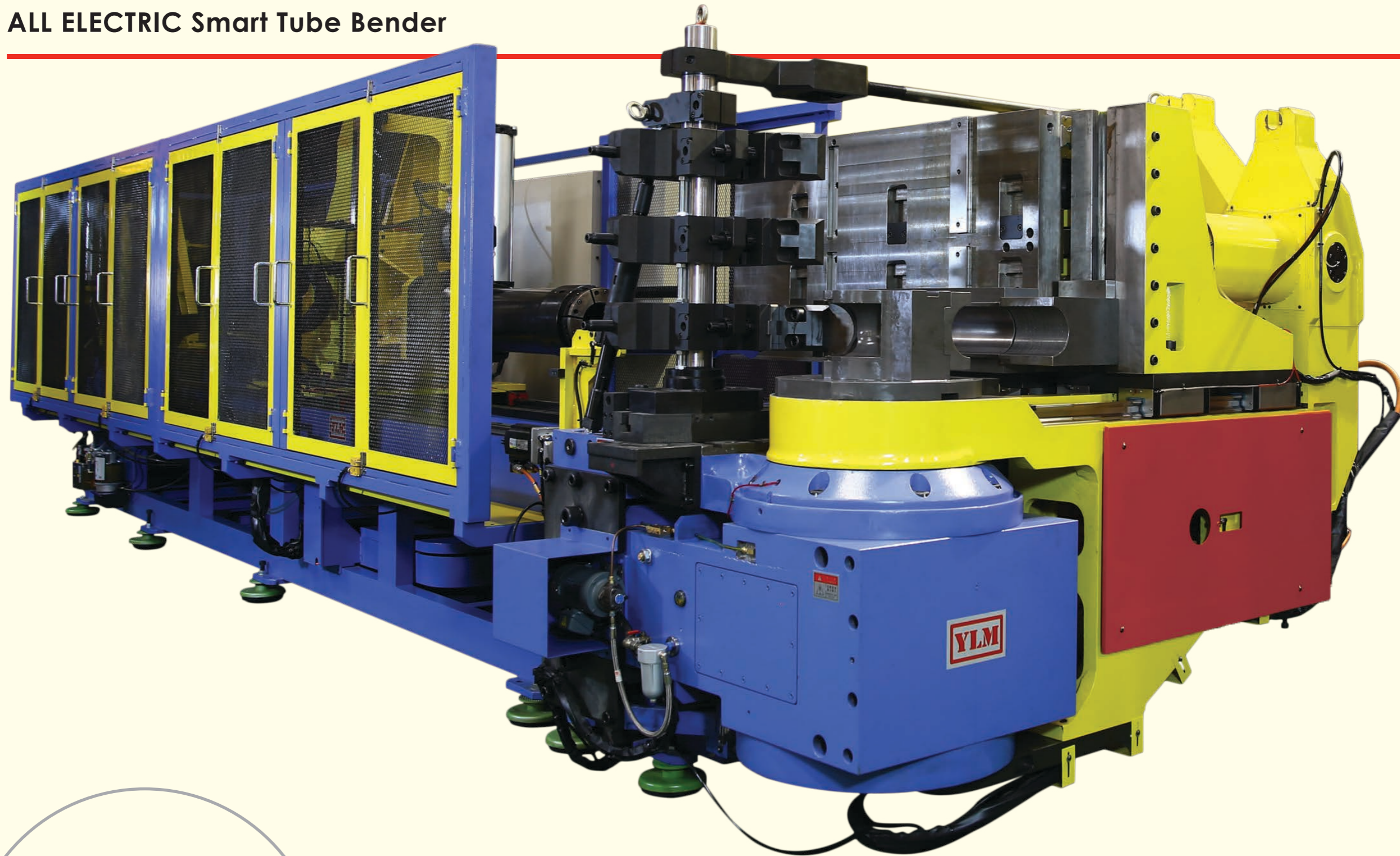

CNC151 MS-AE-11A

Especially for the production of "thick wall" pipes such as Boiler, Heavy Transportation, Shipbuilding, Chemical Engineering, Power Plant, Diesel Engine

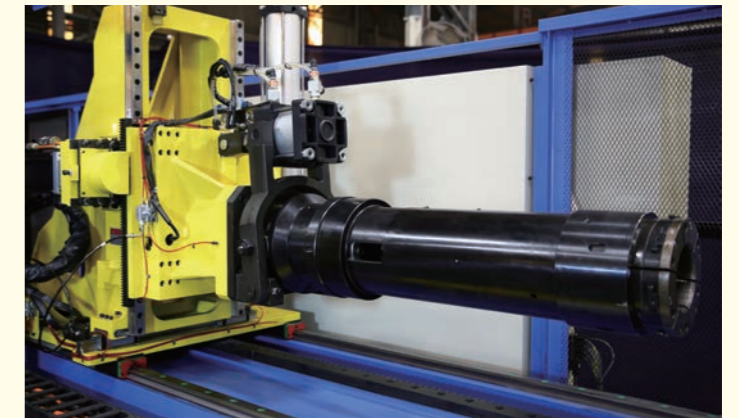
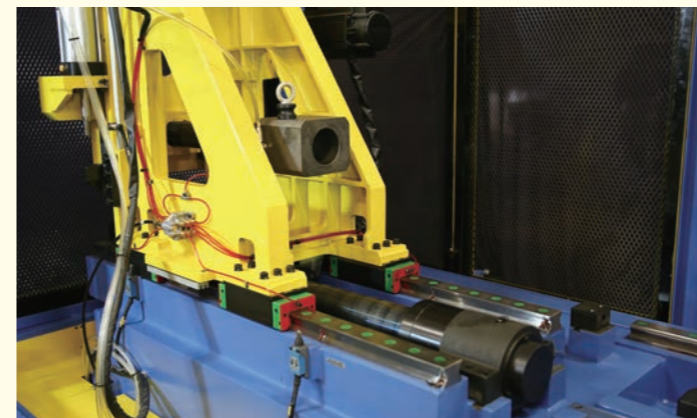

ALL ELECTRIC Smart Tube Bender

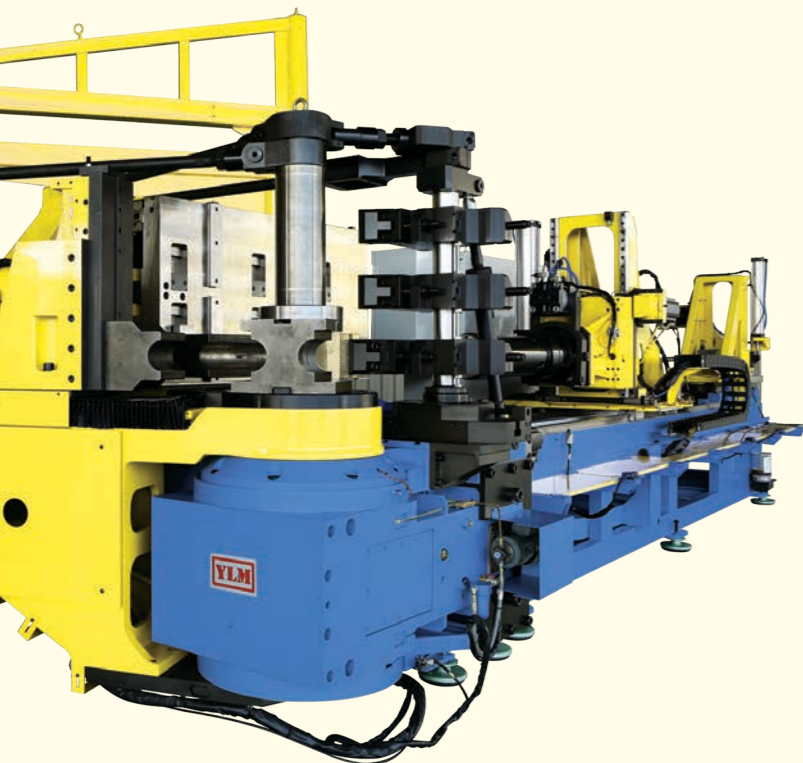
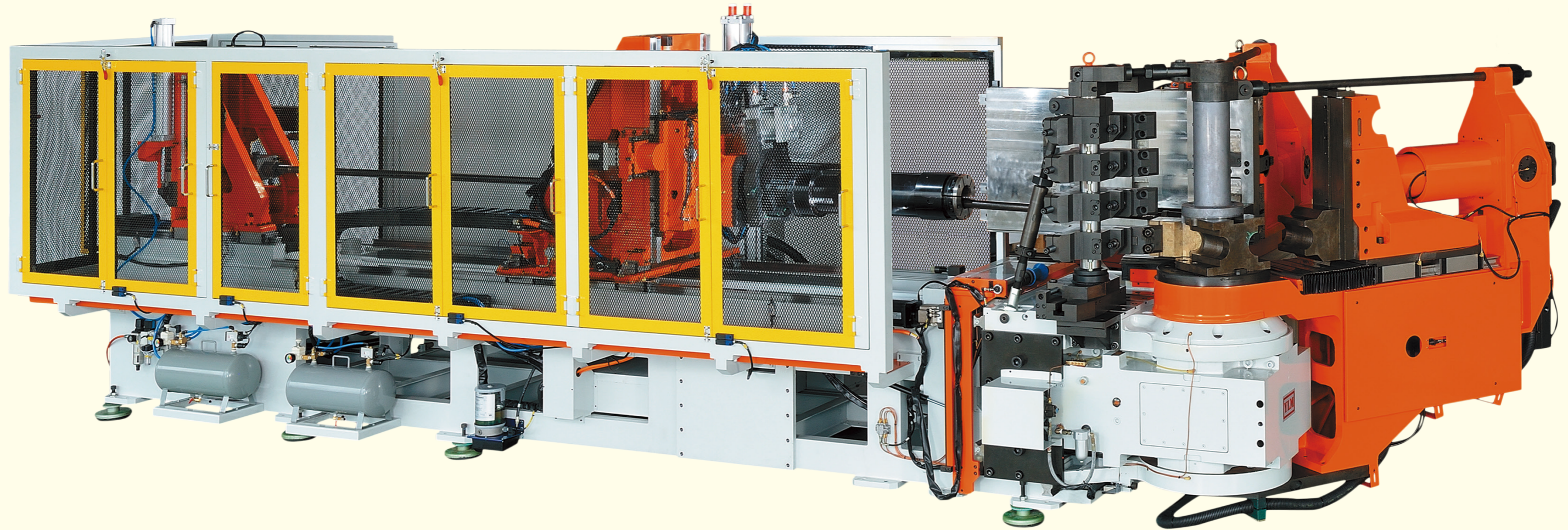

CNC131 MS-AE-11A

Especially for the production of "thick wall" pipes such as Boiler, Heavy Transportation, Shipbuilding, Chemical Engineering, Power Plant, Diesel Engine

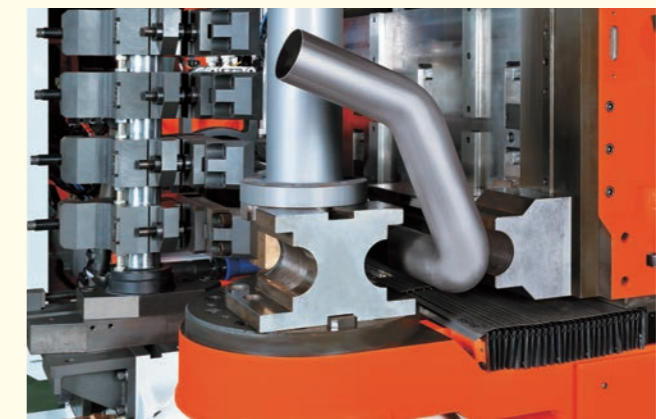

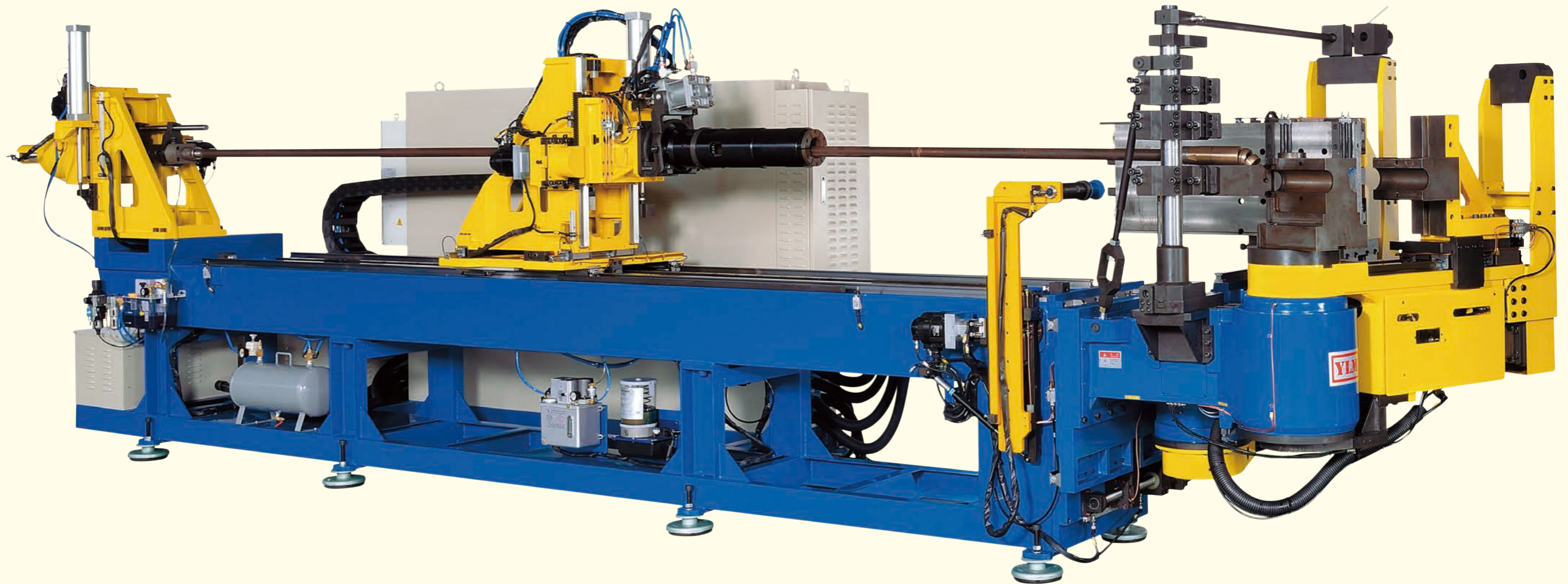

Used for Medium and Large Tubes
with Small Bending Radius

CNC101 MS-RAE-12A

Suitable Industries:

- Exhaust Tube
- Exercise Equipment
- Heavy Transportation
- Shipbuilding
- Chemical Engineering
- Power Plant
- Diesel Engine

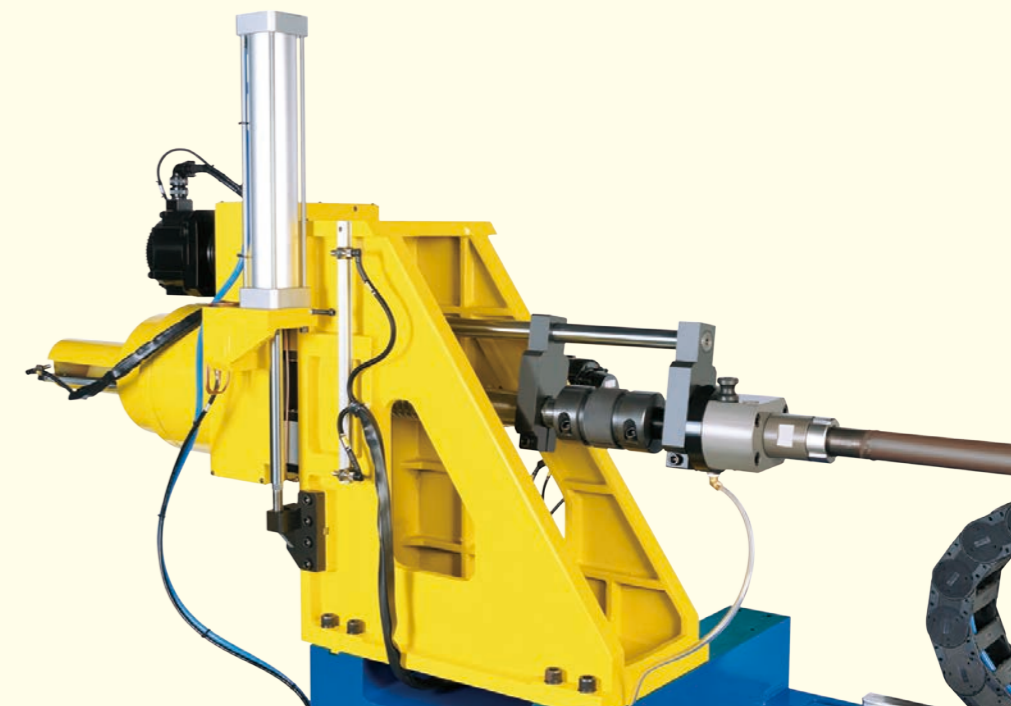
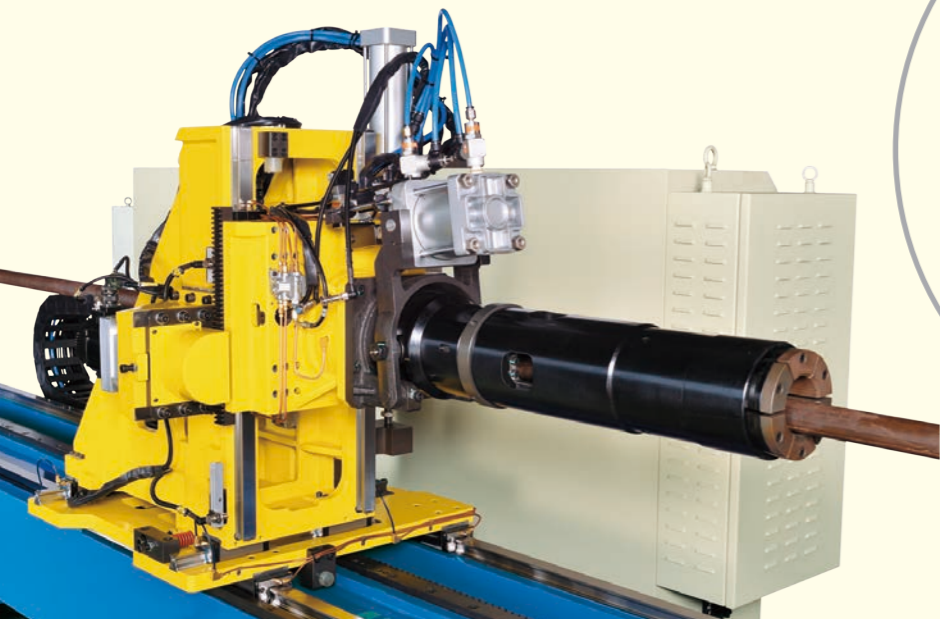

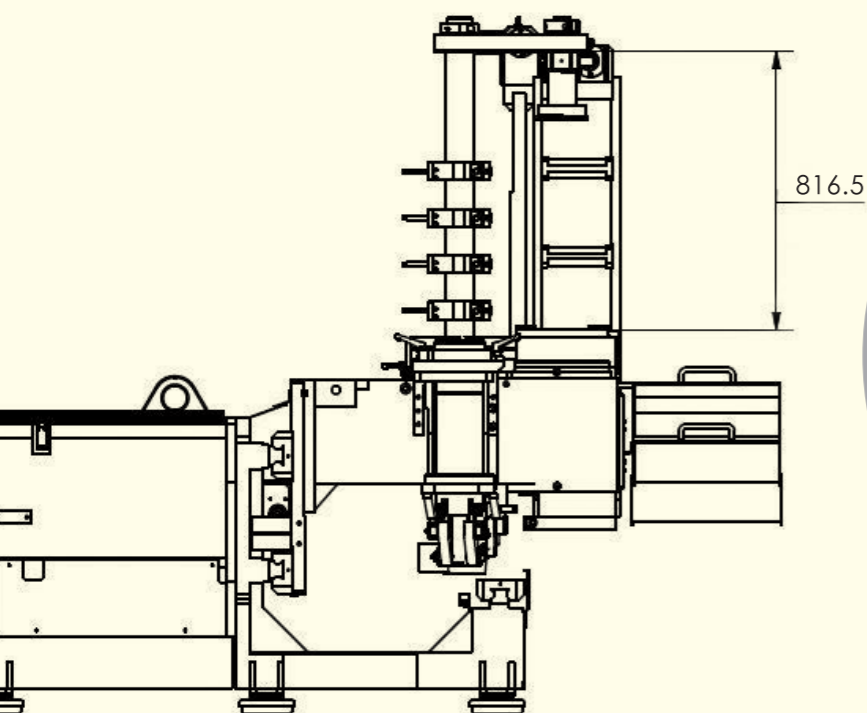
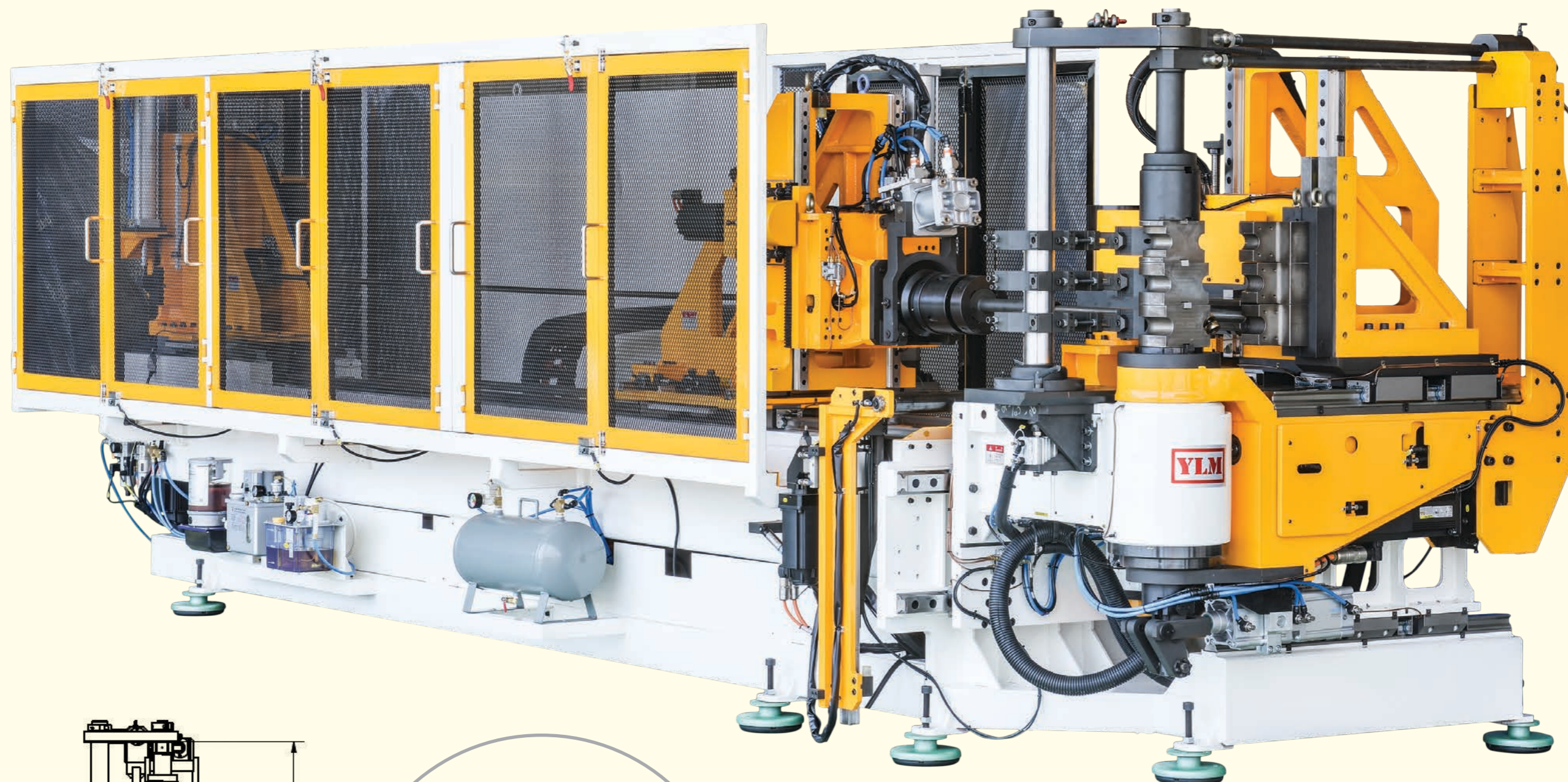

Provide Various Bending of 1DR~∞
Small Radius or Hard to Bend Pipe

CNC91 MS-AE-12A

Multi-Levels

Suitable Industries:

- Handle Bar
- Tubular Furniture
- Architecture
- Aircraft
- Car Seat

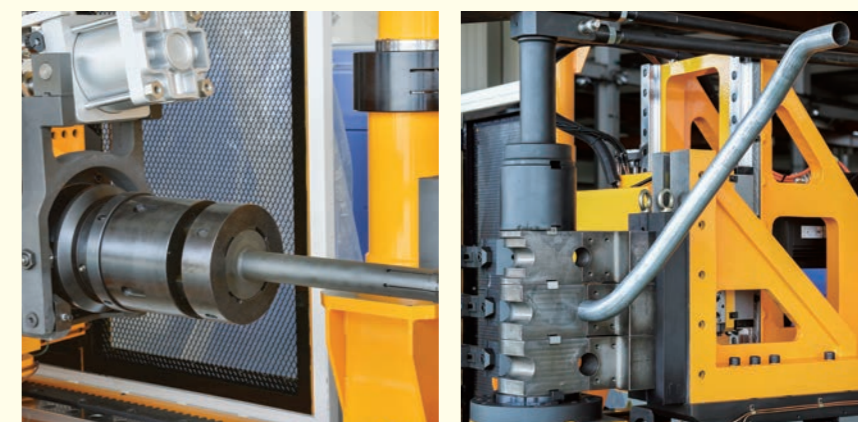

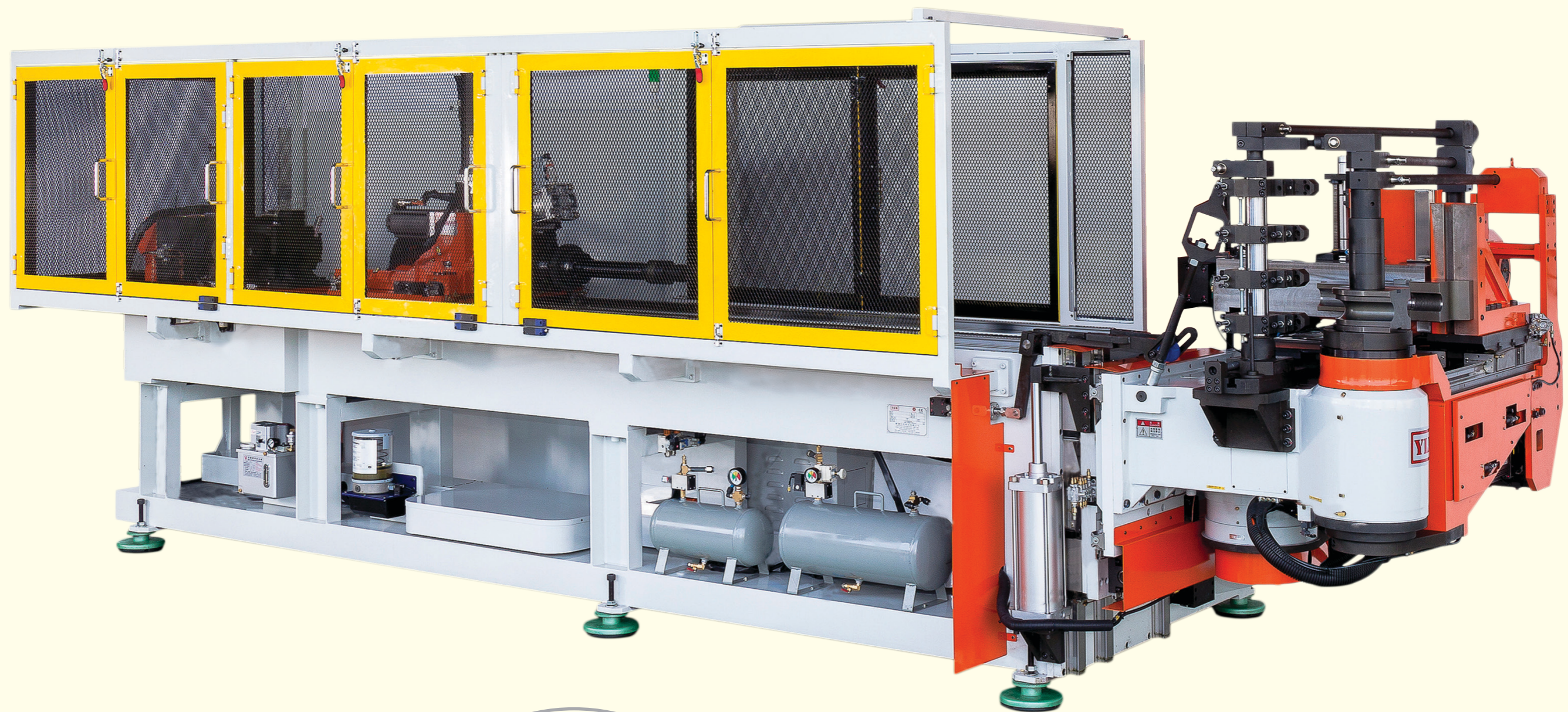

Used for Medium and Large Tubes
with Small Bending Radius

CNC90_{MS-AE-10A}

Suitable Industries:

- Exhaust Tube
- Exercise Equipment
- Heavy Transportation
- Shipbuilding
- Chemical Engineering
- Power Plant
- Diesel Engine

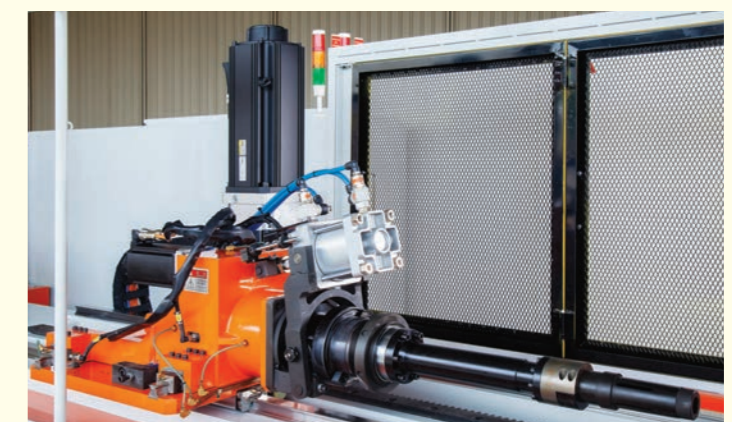

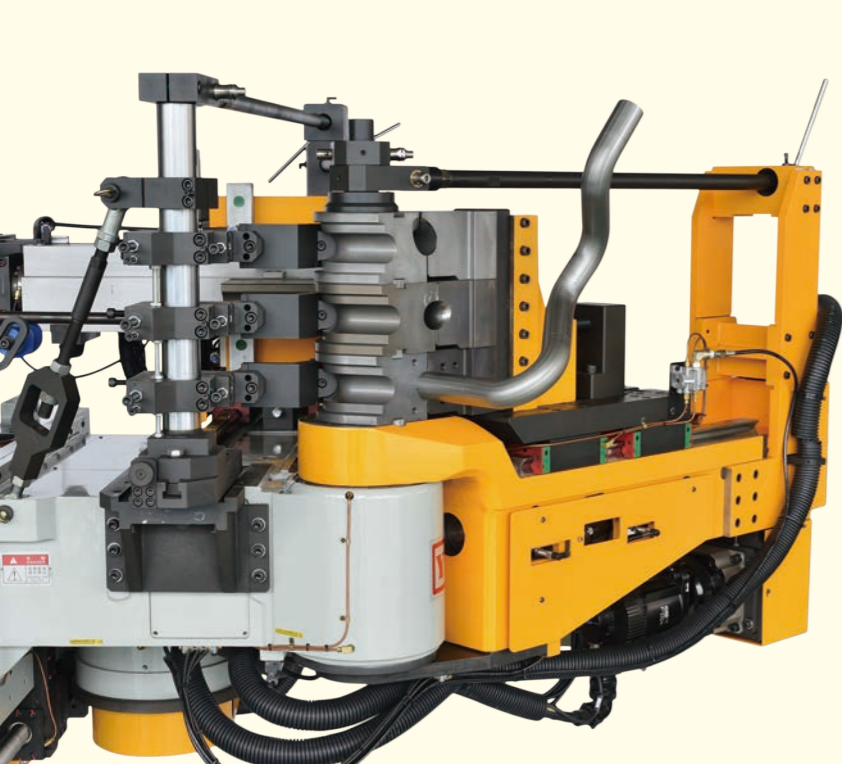
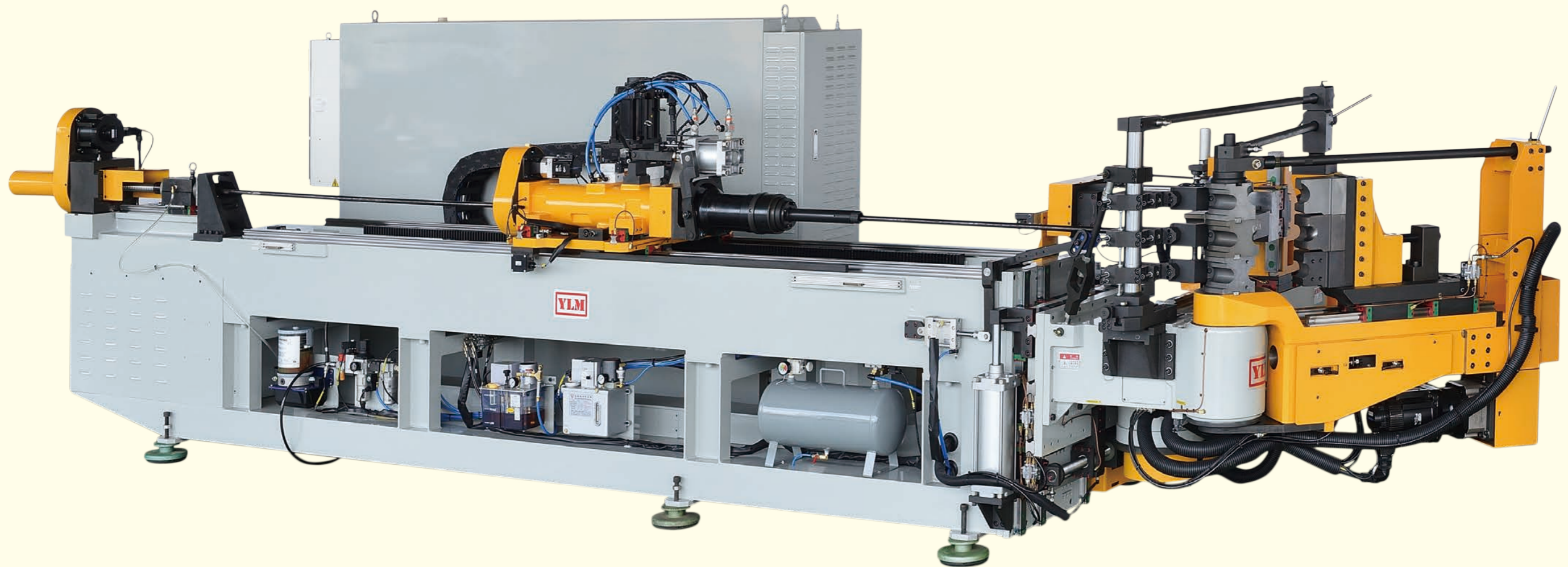

Used for Medium and Large Tubes
with Small Bending Radius

CNC80_{MS-RAE-11A}

Suitable Industries:

- Exhaust Tube
- Exercise Equipment
- Heavy Transportation
- Shipbuilding
- Chemical Engineering
- Power Plant
- Diesel Engine

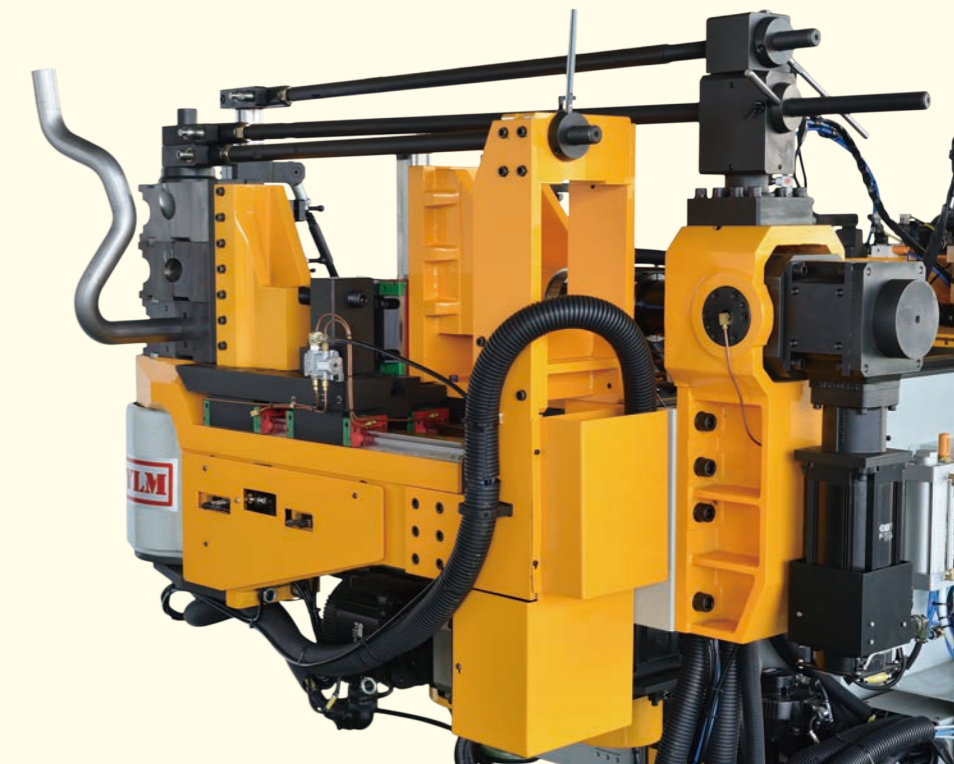



CNC70_{MS-AE-10A}

Provide Various Bending of 1DR~∞ tight Radius and chanllenging bending tasks.

- Suitable Industries:
- Structure Steel
 - Exhaust System
 - Architecture
 - Aerospace
 - Automotive

Servo cutting

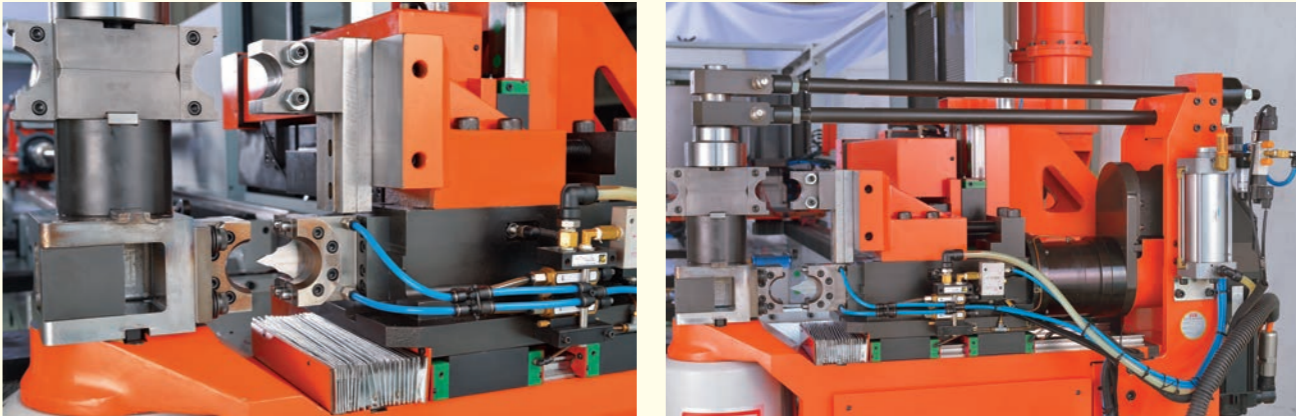

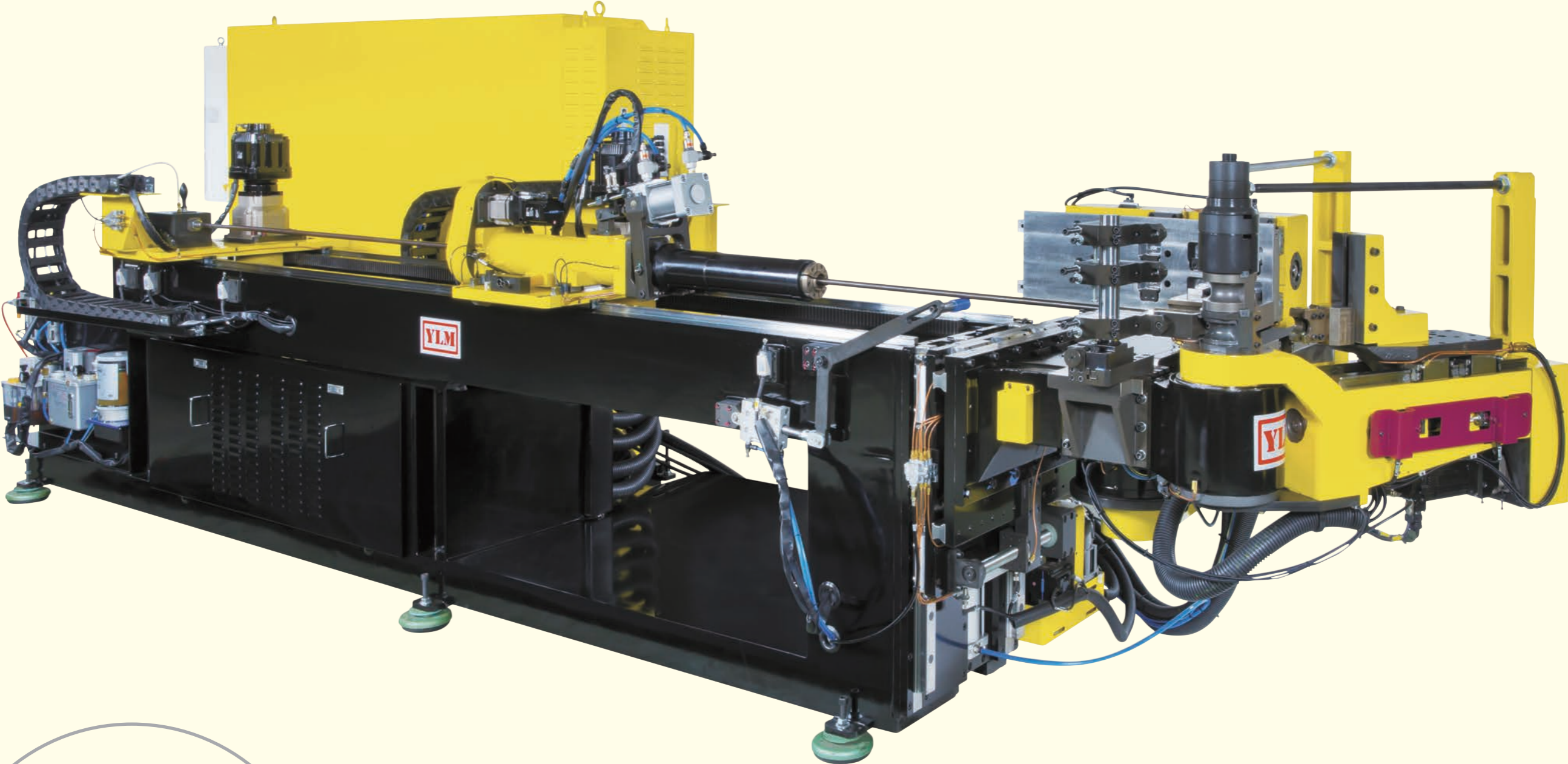

CNC50_{MS-AE-9A}

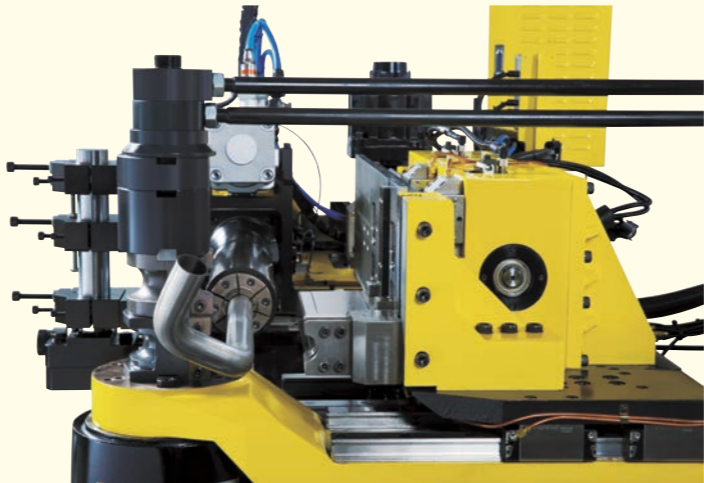

Provide Various Bending of 1DR~∞ tight Radius and challenging bending tasks.

- Suitable Industries:
- Structure Steel
 - Exhaust System
 - Architecture
 - Aerospace
 - Automotive

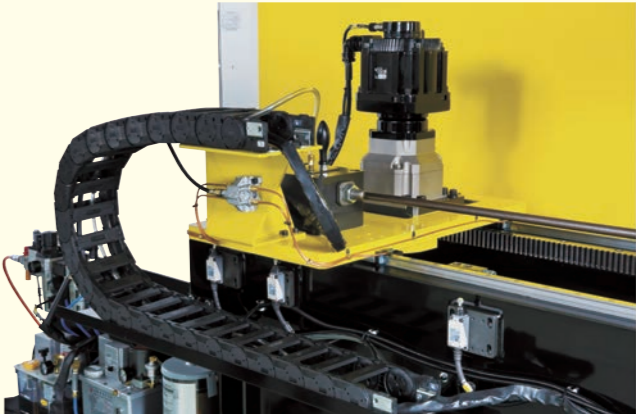

ALL ELECTRIC Smart Tube Bender

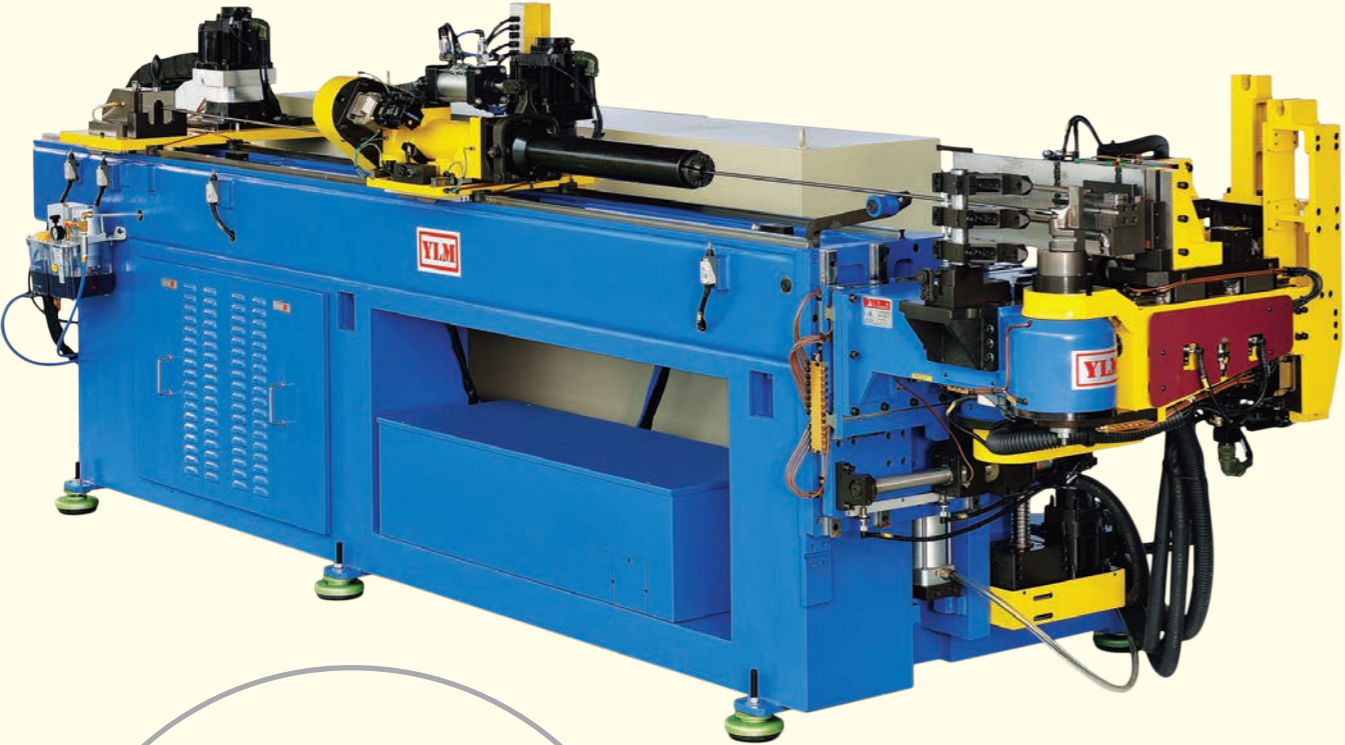

CNC38_{MS-AE-9A}

Automotive Brakes & Fuel Pipes,
Frame of a Motorcycle, bicycle & ATV,
Car Seat, Handle Bar,
Exercise Equipment, Tubular Furniture,
Building Materials, Aircraft

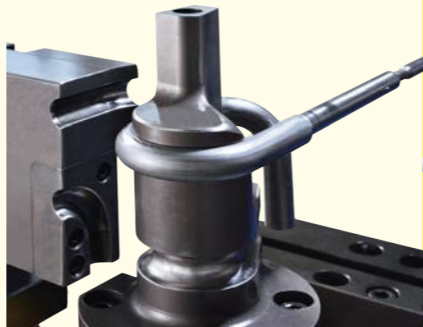
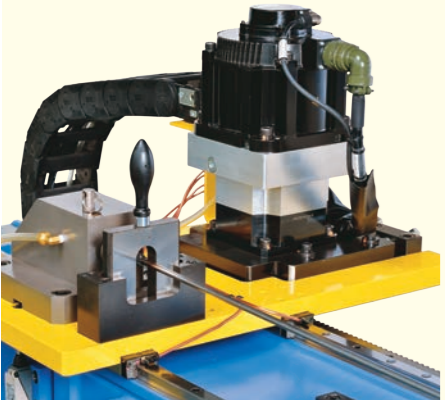

Drive your
productivity
gains, and reach
Industry 4.0

ALL ELECTRIC
L&R Smart Turn Tube Bender

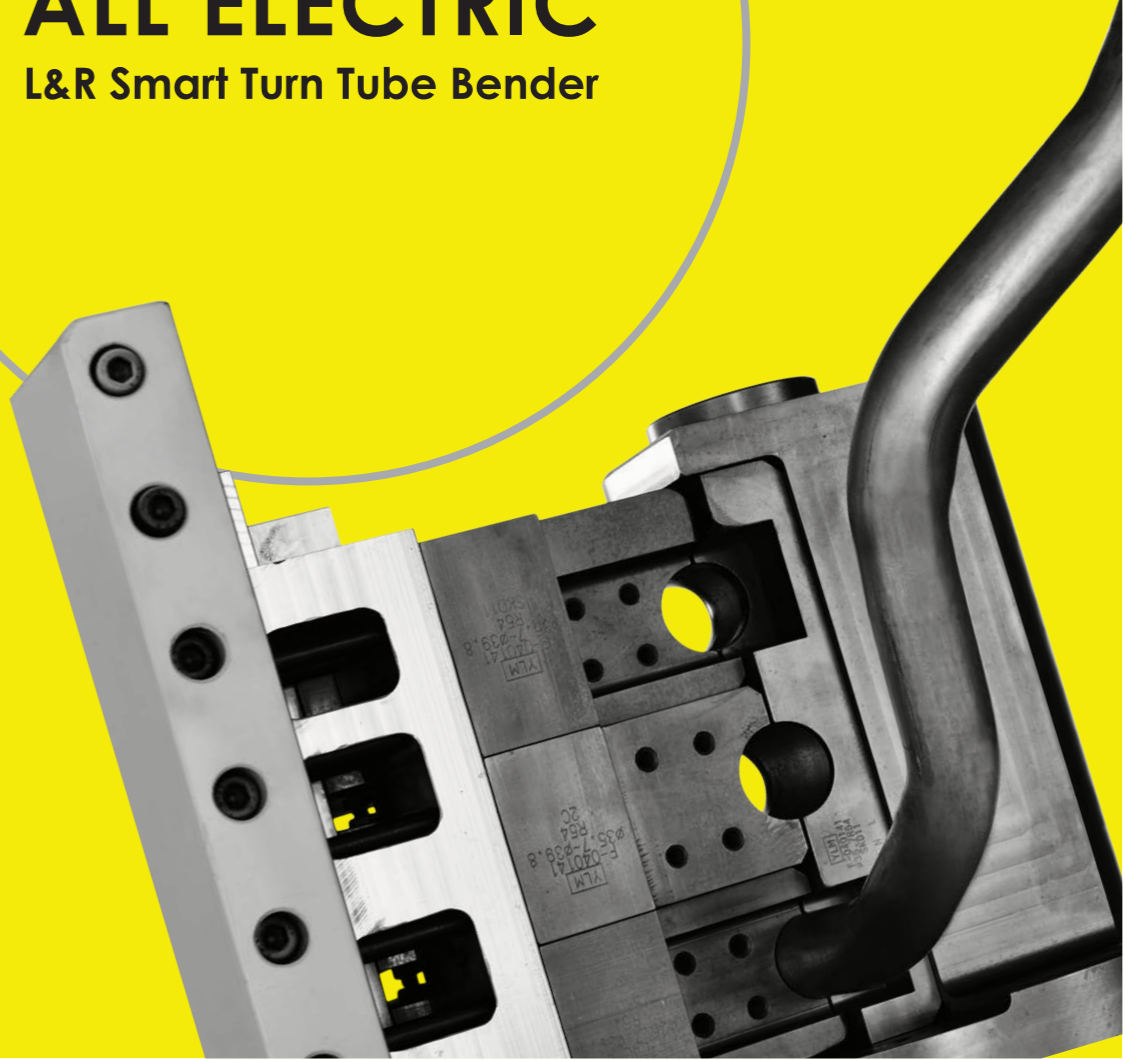



ALL ELECTRIC L&R Smart Turn Tube Bender

Fully electric CNC L&R tube bender is in both left-hand & right-hand bending function. A very practical model to meet various bending demands, suitable for symmetrical tube such as furniture production, hydraulic-oil tubing lines, and HVAC tubing & fluid system of automobiles.



ADVANTAGES

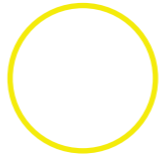

RIGHT-HAND & LEFT-HAND BENDING MACHINE



SUITABLE for SYMMETRICAL BENDING DEMANDS



FEATURES

- Draw And Roller-bending ● Teach-mode CNC Software
- 3D Simulation ● Auto Lubrication System

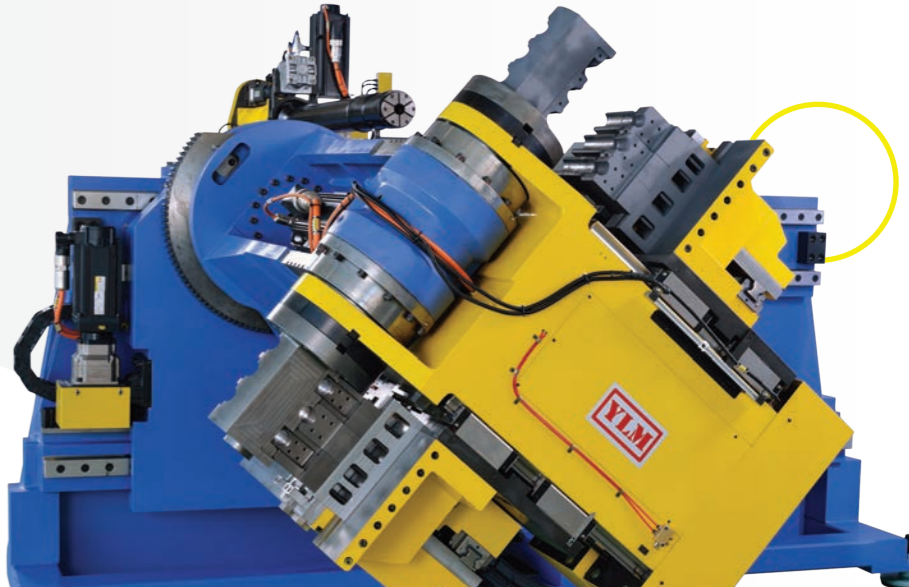
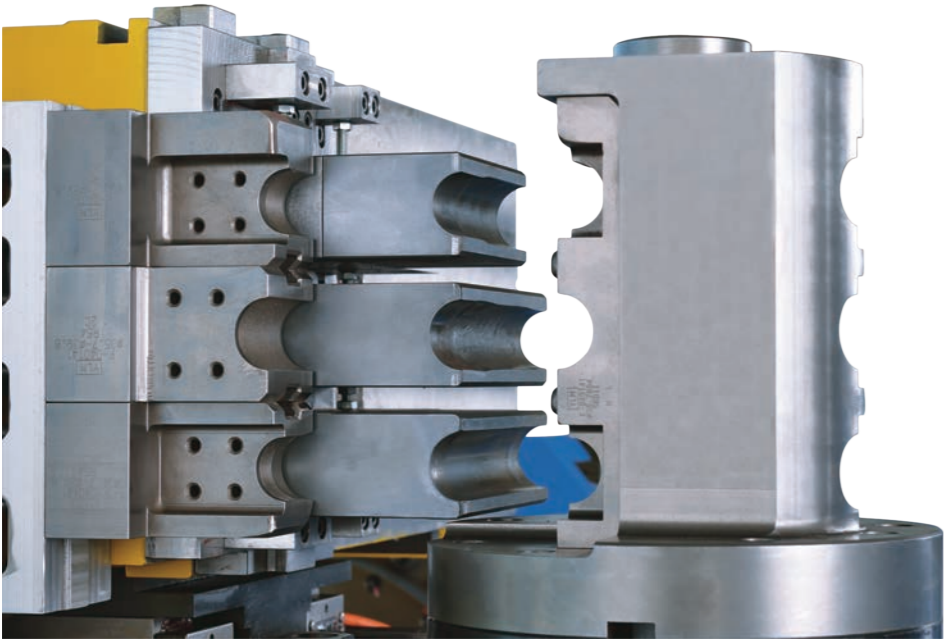

All Electric L&R Smart Turn Tube Bender

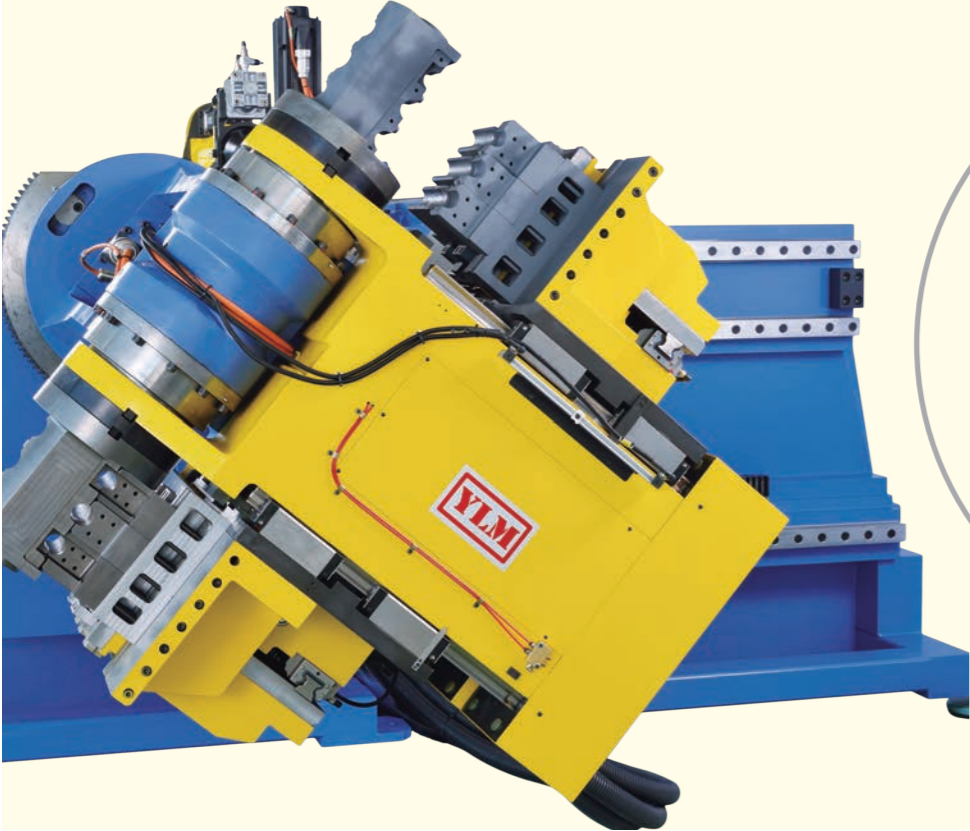

CNC80_{MS-RL-AE-9A}



- Suitable Industries:
- **LARGE VEHICLE BALANCE BEAM**
 - **HEAVY TRANSPORTATION FUEL PIPELINE**
 - **PIPELINE FOR CHEMISTRY**

All Electric L&R Smart Turn Tube Bender

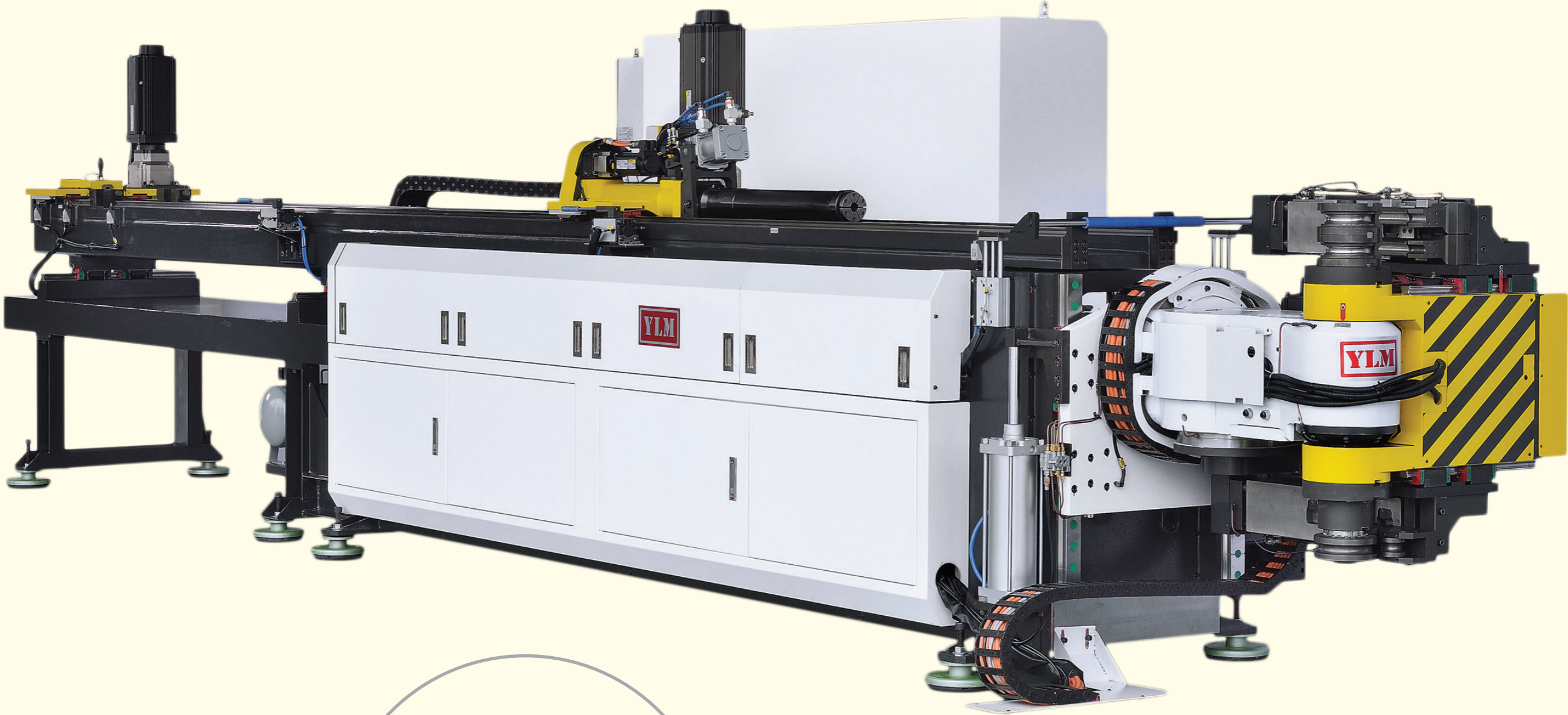

CNC51_{MS-RL-AE-11A}

Suitable Industries:

- Furniture
- Medical Aids
- Sports Equipment
- Structure Steel
- Hydraulic Tube

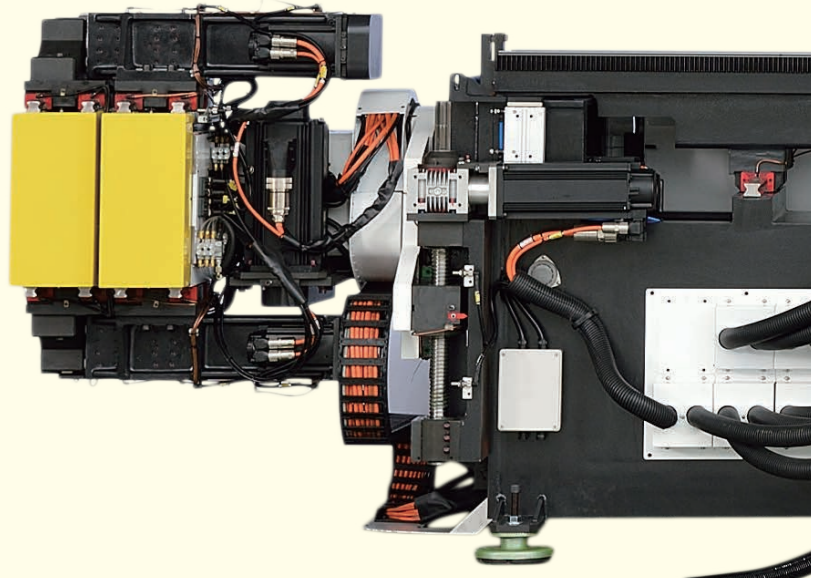
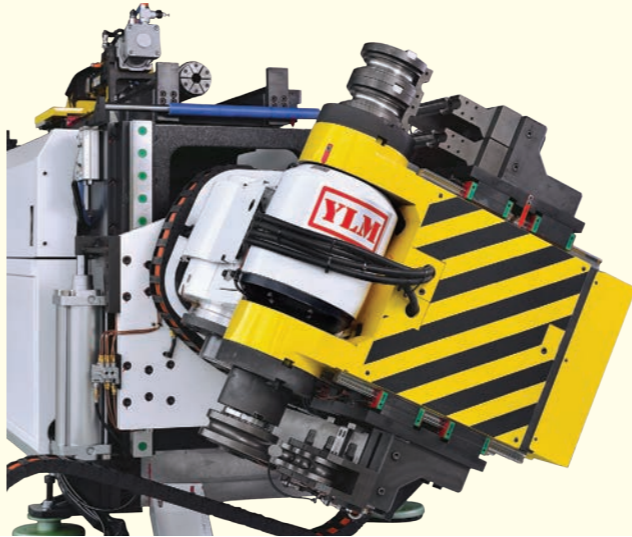

All Electric L&R Smart Turn Tube Bender



CNC38_{MS-RL-AE-8A}

Suitable Industries:

- Furniture
- Medical Aids
- Sports Equipment

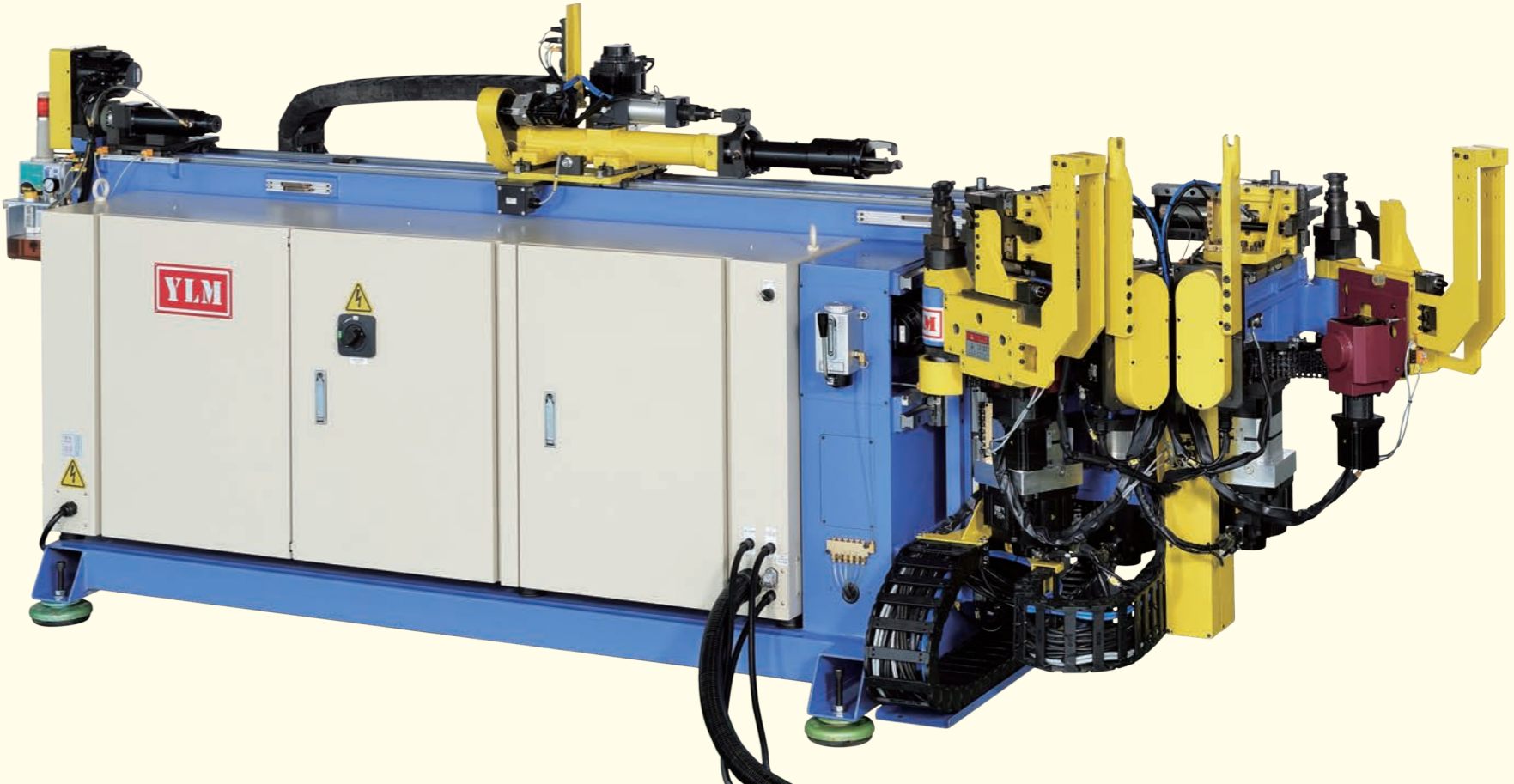

CNC25_{MS-RL-AE-12A}

Suitable Industries:

- Automotive
- Furniture
- Architecture
- Aerospace

Bending Head

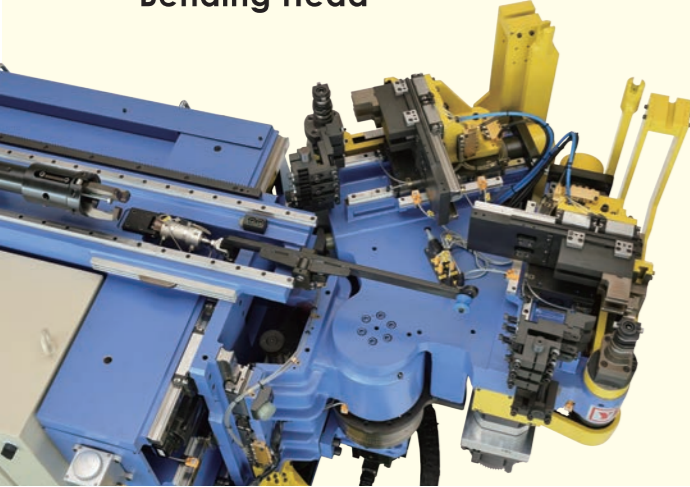

ALL ELECTRIC Smart Tube Bender

SPECIFICATION

| MODEL NO. | CNC181MS-AE | CNC151MS-AE | CNC131MS-AE | (*) CNC101MS-AE | CNC91MS-AE | CNC90MS-AE | (*) CNC80MS-AE | CNC70MS-AE | CNC50MS-AE | CNC38MS-AE | |
|---|-----------------------------|-------------|-------------|-----------------|------------|------------|----------------|------------|------------|------------|------|
| AXIS | 11A | 11A | 11A | 12A | 12A | 10A | 9A | 10A | 9A | 9A | |
| Max. Tube O.D. Bending Capacity (mm) | ∅ 180 | ∅ 150 | ∅ 130 | ∅100 | ∅ 90 | ∅ 90 | ∅ 80 | ∅ 70 | ∅ 50 | ∅ 38 | |
| Max. Tube Wall Thickness (mm) | 4 | 5 | 5 | 4 | 3 | 3 | 3 | 3 | 2.5 | 2 | |
| Max. CLR (mm) | 370 | 370 | 400 | 250 | 200 | 250 | 250 | 180 | 180 | 180 | |
| Bending Radius Difference (mm) S1-S2-S3 | 150 | 150 | 150 | 100 | 90 | 90 | 90 | 90 | 80 | 50 | |
| Max. Bending Angle (°) | 190 | 190 | 190 | 190 | 190 | 190 | 190 | 190 | 190 | 190 | |
| Max. Mandrel Working Distance (mm) | 4500 | 4000 | 3000 | 4000 | 3000 | 2500 | 3000 | 2500 | 2500 | 2000 | |
| Processing Speed | Tube Feeding Speed (mm/sec) | 837 | 837 | 837 | 653 | 1055 | 1143 | 754 | 1143 | 839 | 1693 |
| | Tube Rotation Speed (°/sec) | 506 | 506 | 506 | 348 | 445.7 | 759 | 180 | 1371 | 390 | 780 |
| | Tube Bending Speed (°/sec) | 19.5 | 52 | 62.5 | 32.1 | 105 | 80 | 62.5 | 156.8 | 120 | 283 |
| Repeatability | Tube Feeding Precision (mm) | ±0.1 | ±0.1 | ±0.1 | ±0.1 | ±0.1 | ±0.1 | ±0.1 | ±0.1 | ±0.1 | ±0.1 |
| | Tube Rotation Precision (°) | ±0.1 | ±0.1 | ±0.1 | ±0.1 | ±0.1 | ±0.1 | ±0.1 | ±0.1 | ±0.1 | ±0.1 |
| | Tube Bending Precision (°) | ±0.1 | ±0.1 | ±0.1 | ±0.1 | ±0.1 | ±0.1 | ±0.1 | ±0.1 | ±0.1 | ±0.1 |
| Total Power (kw) | 61.5 | 124 | 83.1 | 114.45 | 63.03 | 65 | 48.05 | 68.5 | 63.49 | 51.06 | |
| Overall Weight (kg) | 20850 | 17735 | 16355 | 9620 | 8230 | 8200 | 7000 | 5397 | 5200 | 3190 | |
| Operation Height (mm) | 1369 | 1238 | 1238 | 1289 | 1172 | 1275 | 1170 | 1170 | 1145 | 1200 | |
| Machine Length (mm) | 9528 | 8467 | 7531 | 8094 | 6850 | 6114 | 6807 | 5570 | 5269 | 4432 | |
| Machine Width (mm) | 3147 | 2706 | 2704 | 2132 | 1954 | 1977 | 1804 | 1637 | 1676 | 1324 | |
| Machine Height (mm) | 2364 | 2198 | 2198 | 2071 | 2039 | 1925 | 1900 | 1914 | 1914 | 1630 | |

OPTIONAL FUNCTION

Push Bending • 3D Simulation of Bending Process • Hole Punching • Split Die Device • ID Collet • Tube Boost • 3-Jaw Collet • Remote Access • Cutting Device
 Servo Pressure Die Boost • Tube Loading & Unloading Equipment • Quick Tooling Change System • Weld Seam Detection • Bending Work Cell (Automation)

OPTIONAL FUNCTION

Bending Tooling Adaption for Customers Existing Tooling Sets.

(*) CNC101MS-AE and CNC80MS-AE are controlled by Yaskawa motors.

Above options are selectable, please discuss your requirements with our sales representatives.

The above machine specification is subject to change without previous notice due to continuous improvement of R&D.

All Electric L&R Smart Turn Tube Bender

SPECIFICATION

| MODEL NO. | CNC80-RLR | CNC51-RLR | CNC38-RLR (*) | CNC25-RLT (*) |
|---|-----------------------------|-----------|---------------|---------------|
| AXIS | 10A | 11A | 8A | 12A |
| Max. Tube o.d. Bending Capacity (mm) | ∅ 80 | ∅ 50 | ∅38 | ∅25 |
| Max. Tube Wall Thickness (mm) | 3 | 2.5 | 2 | 1.5 |
| Max. CLR (mm) | 200 | 180 | 150 | 100 |
| Bending Radius Difference (mm) S1-S2-S3 | 90 | 80 | 50 | 40 |
| Max. Bending Angle (°) | 190 | 190 | 190 | 185 |
| Max. Mandrel Working Distance (mm) | 2500 | 2500 | 2000 | 1800 |
| Processing Speed | Tube Feeding Speed (mm/sec) | 1000 | 850 | 1230 |
| | Tube Rotation Speed (°/sec) | 260 | 450 | 360 |
| | Tube Bending Speed (°/sec) | 75 | 160 | 135 |
| Repeatability | Tube Feeding Precision (mm) | ±0.1 | ±0.1 | ±0.1 |
| | Tube Rotation Precision (°) | ±0.1 | ±0.1 | ±0.1 |
| | Tube Bending Precision (°) | ±0.1 | ±0.1 | ±0.1 |
| Total Power (kw) | 66.5 | 55 | 32 | 17.5 |
| Overall Weight (kg) | 14150 | 5600 | 4640 | 3200 |
| Operation Height (mm) | 1164 | 1245 | 1240 | 1200 |
| Machine Length (mm) | 6384 | 8650 | 4900 | 3700 |
| Machine Width (mm) | 2266 | 1750 | 1770 | 1350 |
| Machine Height (mm) | 1877 | 1650 | 1900 | 1510 |

OPTIONAL FUNCTION

- Push Bending • 3D Simulation of Bending Process • 3D Simulation of Tube Application • Hole Punching
- Split Die Device • ID Collet • Tube Boost • 3-Jaw Collet • Cutting Device
- Servo Pressure Die Boost • Simple Loading & Unloading

(*) CNC38-RLR and CNC25-RLT are controlled by Yaskawa motors.

Above options are selectable, please discuss your requirements with our sales representatives.

The above machine specification is subject to change without previous notice due to continuous improvement of R&D.

YLM

www.ylm.com.tw

**YING HAN
Technology
Co., Ltd.**

PHONE

+ 886-6-3843189

FAX

+ 886-6-3843205

e-Mail

sales@ylm.com.tw
service@ylm.com.tw
ylm.de@ylm.com.tw

No.50, Keji 1st Rd.,
Annan Dist.,
Tainan City 709,
Taiwan.



+886-972-616-911

YLM offers a 24 hour non-stop global service hot line, providing zero time difference technical support with good adaptability for the rapid changing industries. YLM is dedicated to be your valuable partner.

You care, YLM cares.

YLM develops our own CNC software which is based on Windows XP / Windows 7 with ability to import XYZ information from .dxf / STEP files translating to YBC data. YLM software uses 3D simulation software to preview and eliminate bending interferences. The YLM software is flexible to meet our clients requests to achieve efficient production.

You Care, YLM Cares

YLM provides moment-to-moment service without time difference or language barrier from each YLM local office globally.